

Appendix L

**NOTE: Appendix Information is for Reference Only.
Contact Local Entity Engineer for Current Information.**

Loveland Thermoplastic Standards
(City of Loveland only)

2013 THERMOPLASTIC STANDARDS



TRAFFIC OPERATIONS

CITY OF LOVELAND

RYAN BIERMANN 970-685-8007
DAVID GOODMAN 970-567-1243

PAINT MARKING STANDARDS



TRAFFIC OPERATIONS

CITY OF LOVELAND
RYAN BIERMANN 970-685-8007
DAVID GOODMAN 970-567-1243

THERMO DIMENSION ORIGINALS



City Of Loveland
Traffic Operations
1/17/13

FLINT TRADING, INC.

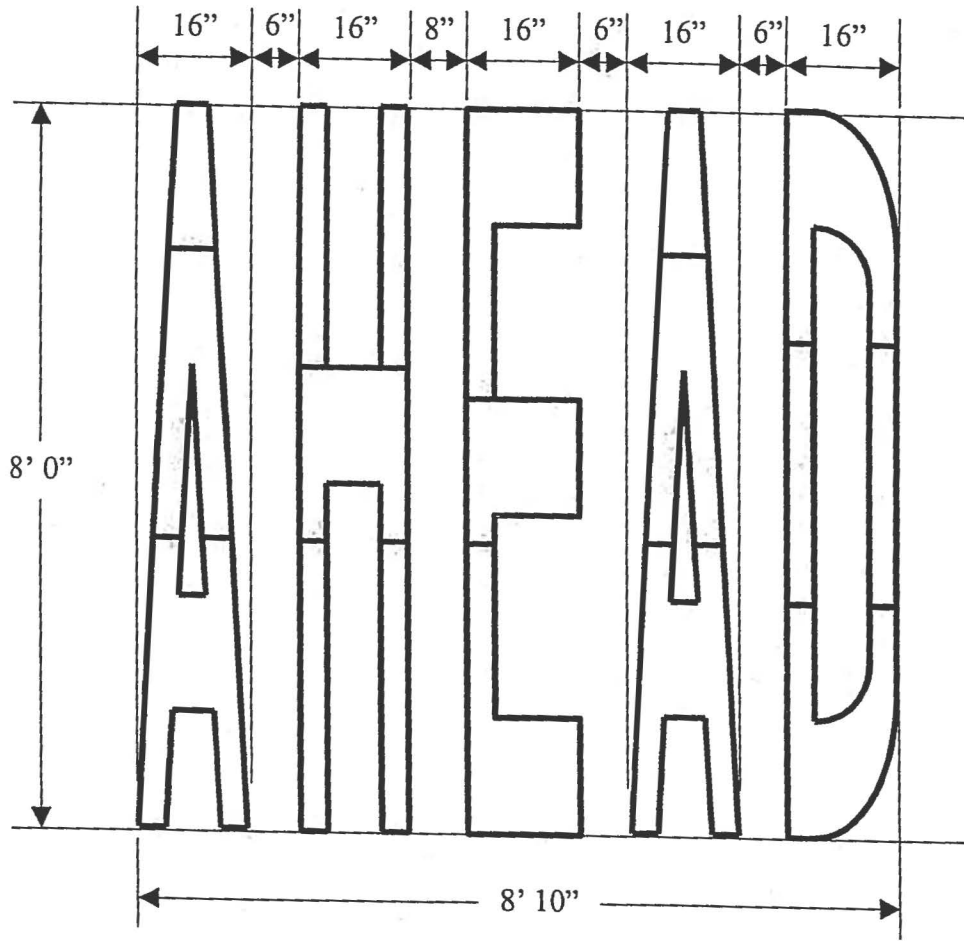

8' "AHEAD"

Premark Design Number 130106

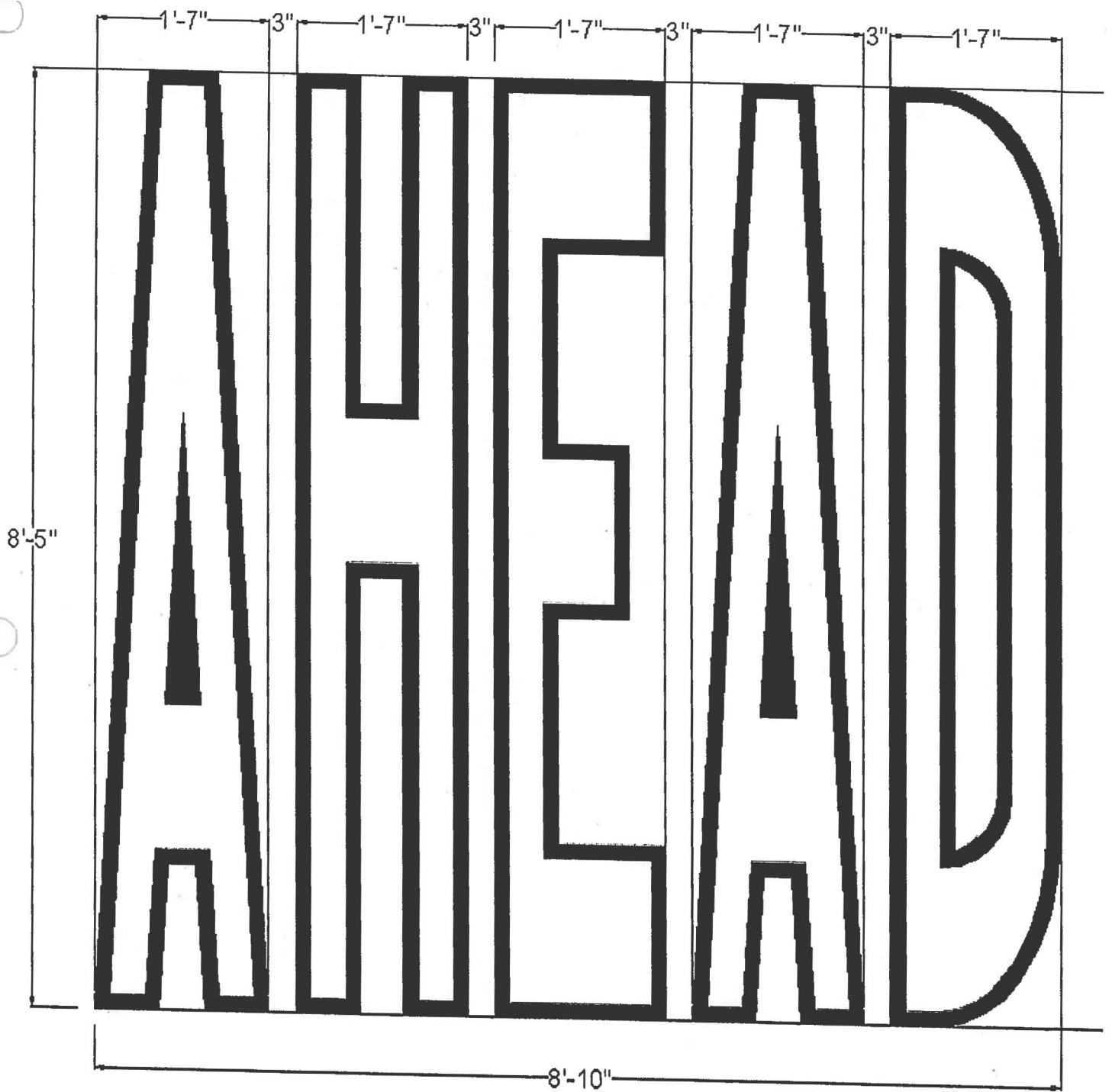

8' "AHEAD" w/1.5" Contrast

Design Number

8130106CONT

FLINT TRADING, INC.

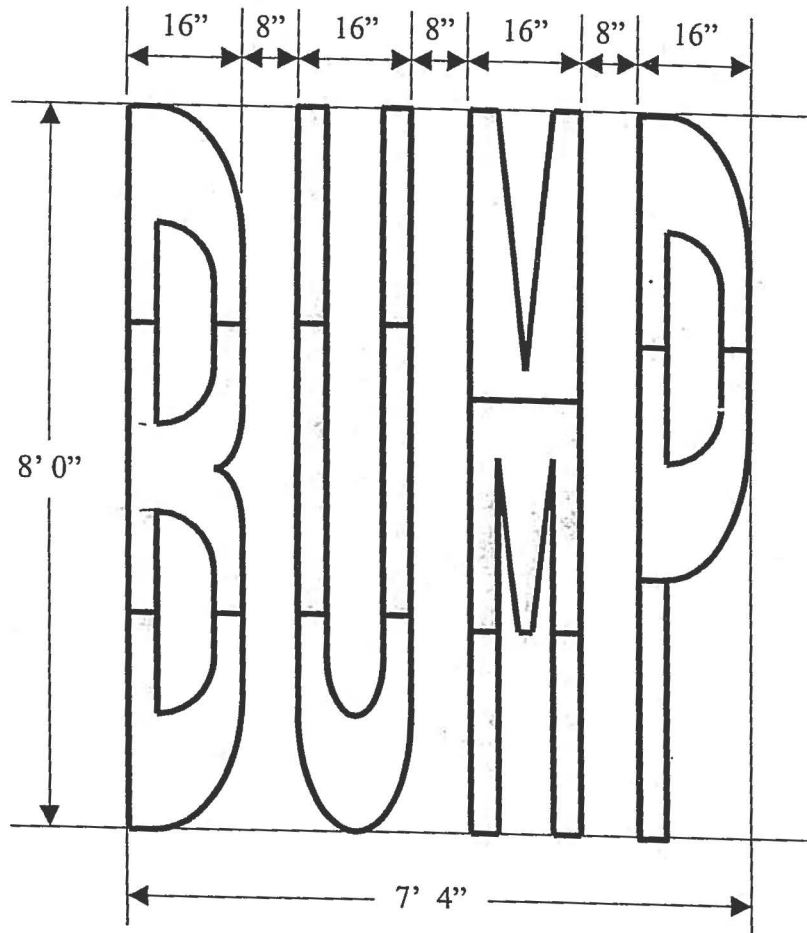

8' "BUMP"

Premark Design Number 130145

FLINT TRADING, INC.

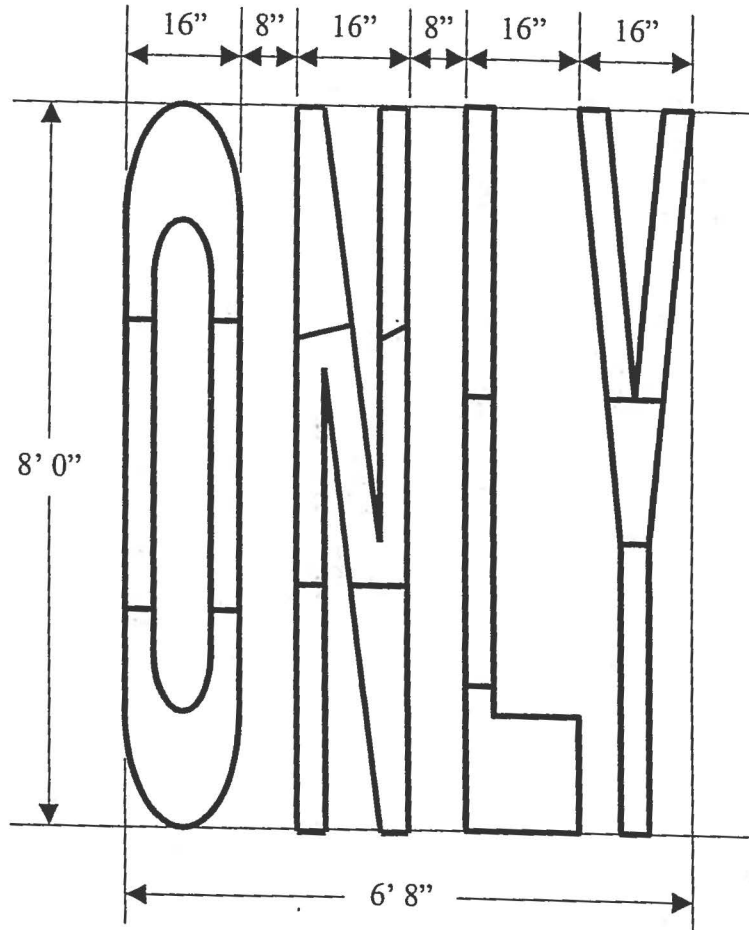

8' "ONLY"

Premark Design Number 130102

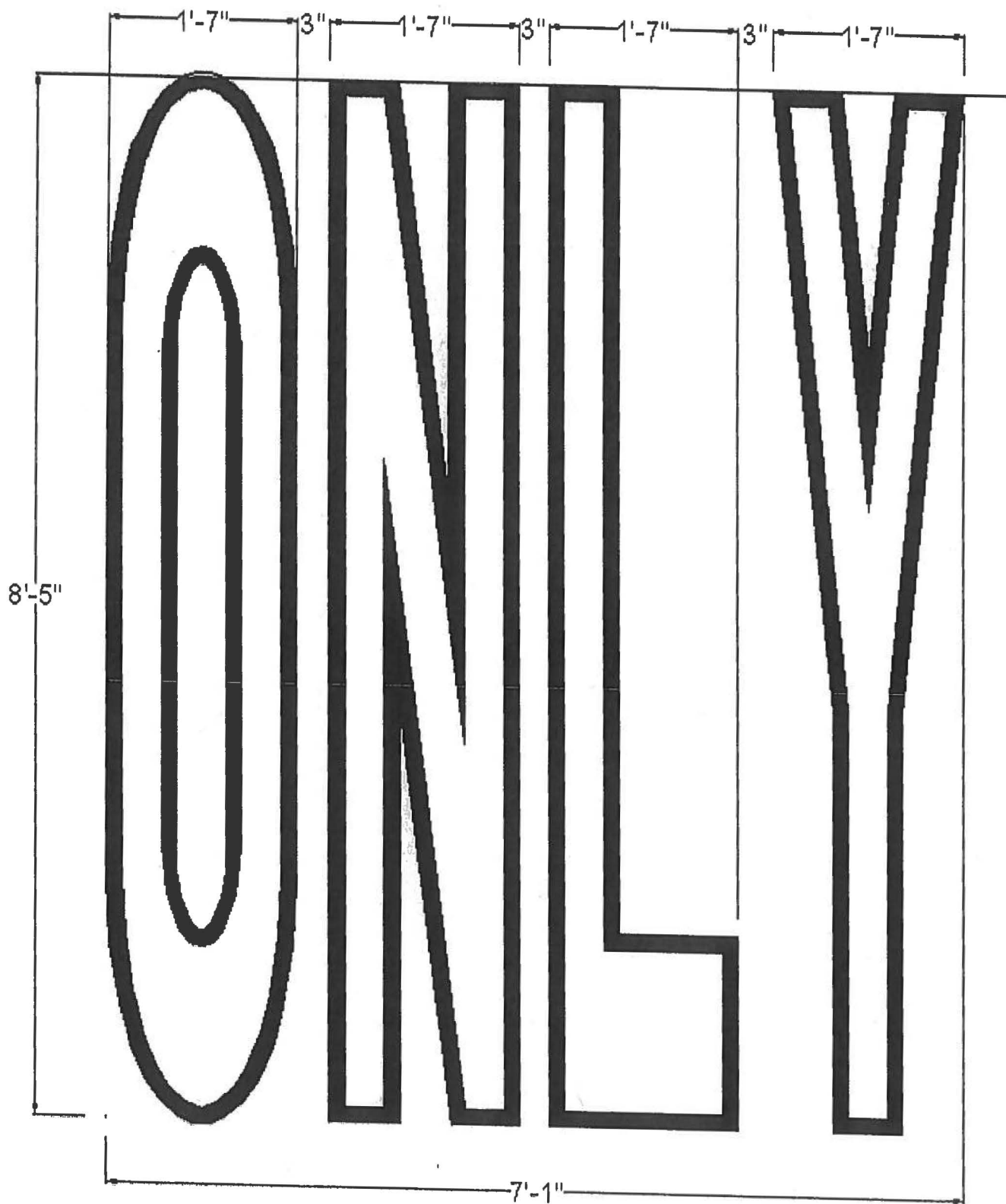

8' "ONLY" w/Contrast

Design Number

130102CONT

FLINT TRADING, INC.

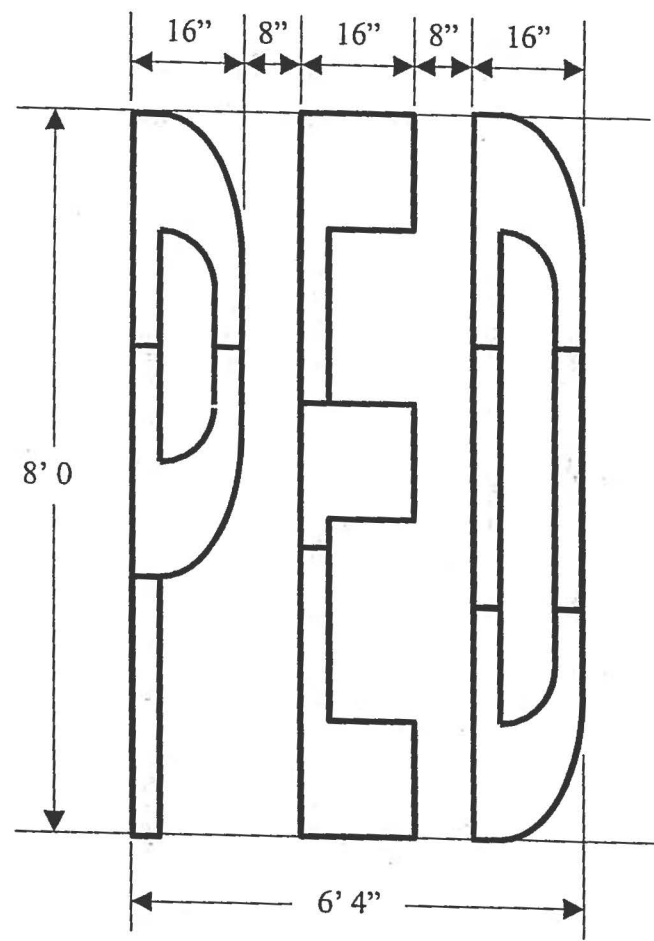

8' "PED"

Premark Design Number 130114

FLINT TRADING, INC.

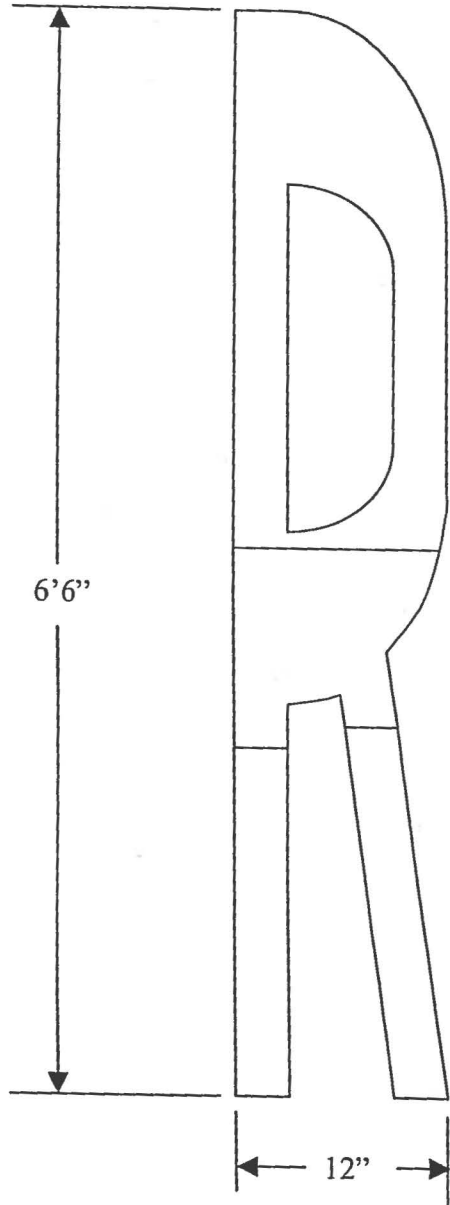

6'6" "R" FHWA

Premark Design Number 130203

Flint
TRADING INC.™

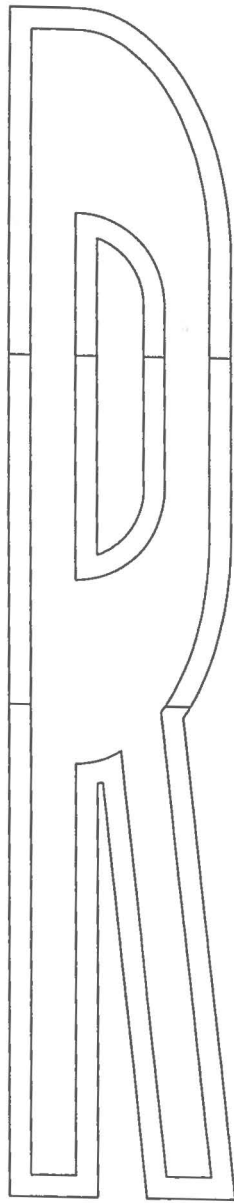

6' 6" "R" FHWA CONTRAST RETROFIT

Design Number

130203-CONT

Mail Address: P.O. Box 160 * Thomasville, NC 27361 * Delivery Address: 115 Todd Court * Thomasville, NC 27360
Phone (336) 475-6600 * Fax (336) 475-7900 * E-Mail: flint@flintrading.com, Web: www.flintrading.com

FLINT TRADING, INC.

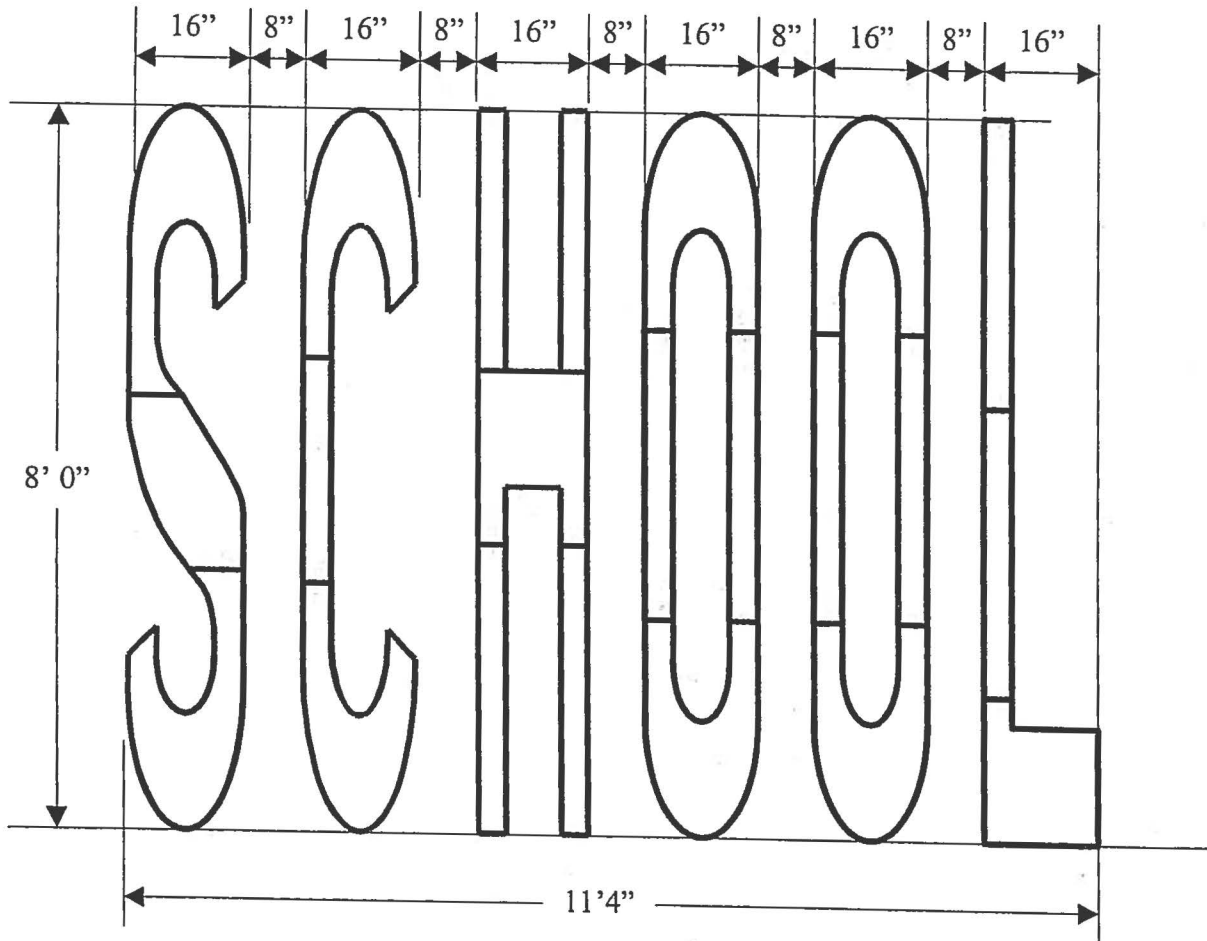

* Spacing Can Be Reduced From 8" To 4" If Required Due To Narrow Lane.

8' "SCHOOL"

Premark Design Number 110101

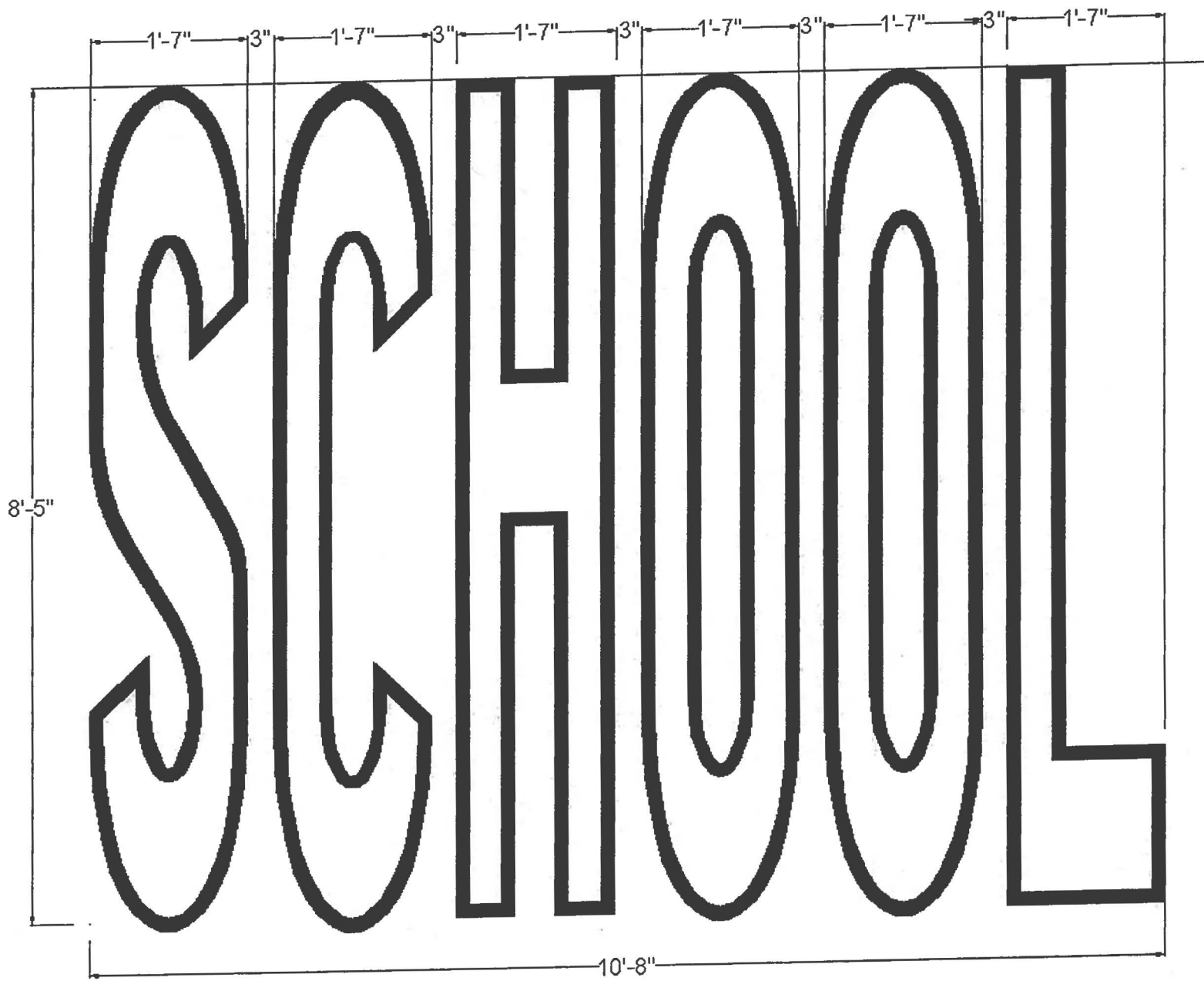

8' "SCHOOL" w/1.5" Contrast

Design Number

110101CONT

FLINT TRADING, INC.

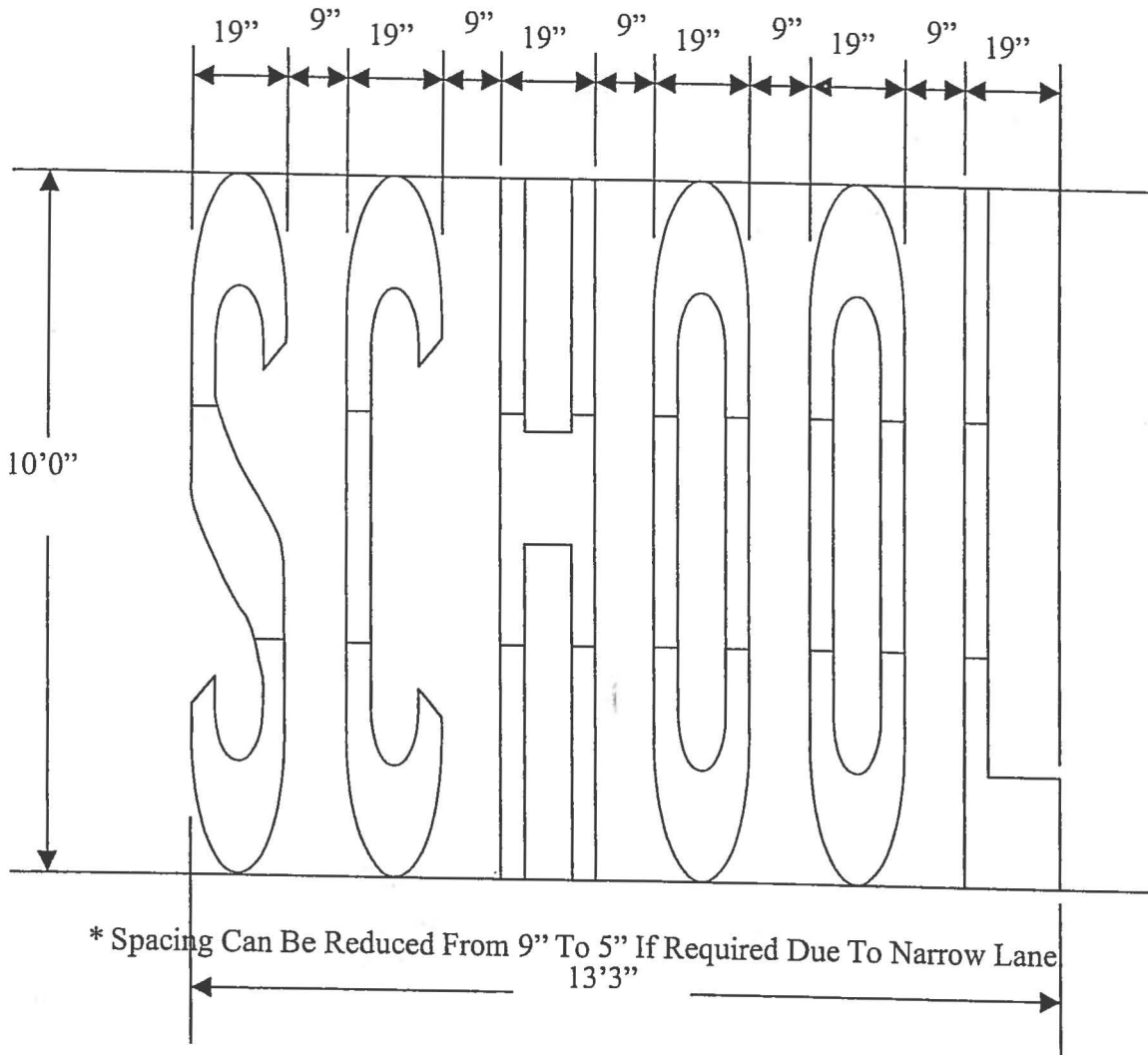

10' SCHOOL

Premark Design Number 120100

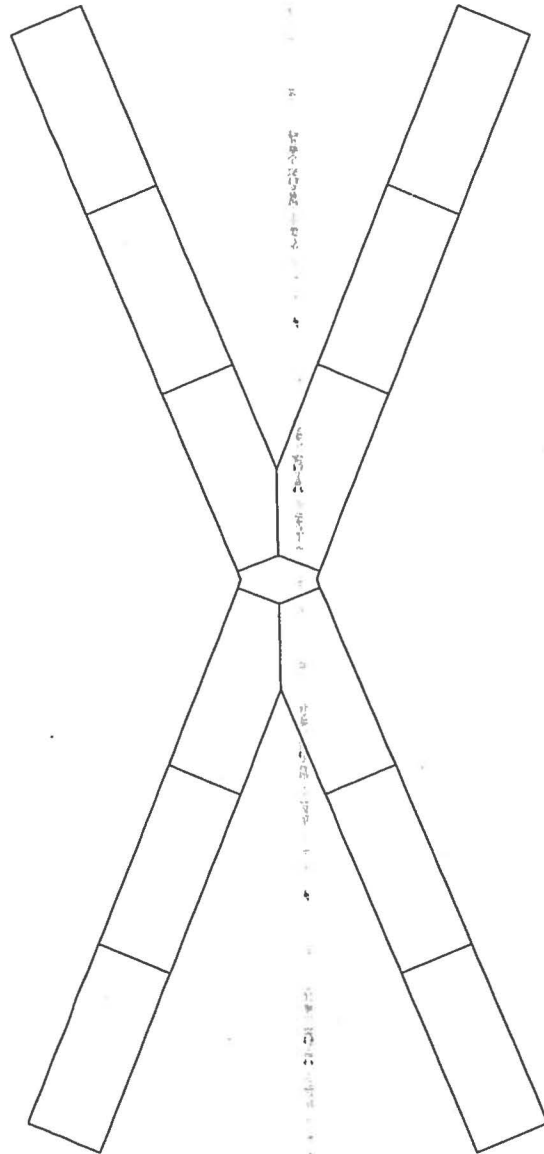

16 x 20' RR Kit Letter 'X'

PREMARK Design Number 130103

Mail Address: P.O. Box 160 * Thomasville, NC 27361 * Delivery Address: 115 Todd Court * Thomasville, NC 27360

Phone (336) 475-6600 * Fax (336) 475-7900 * E-Mail: flint@flintrading.com, Web: www.flintrading.com

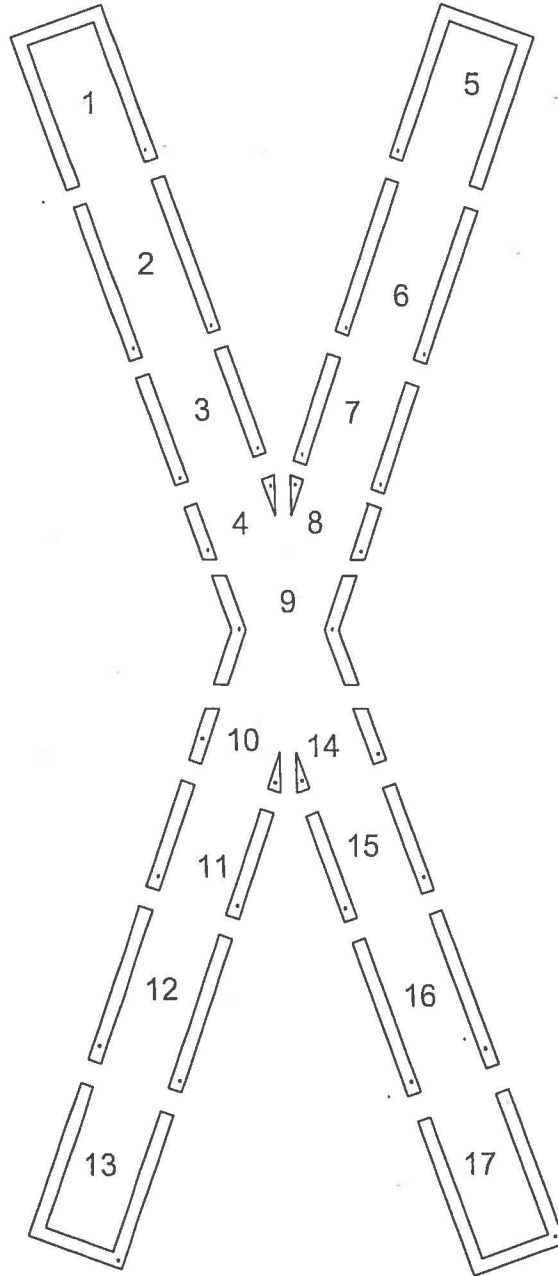

16 X 20 RXR 'X' CONTRAST

Design Number

130103-CONT

FLINT TRADING, INC.

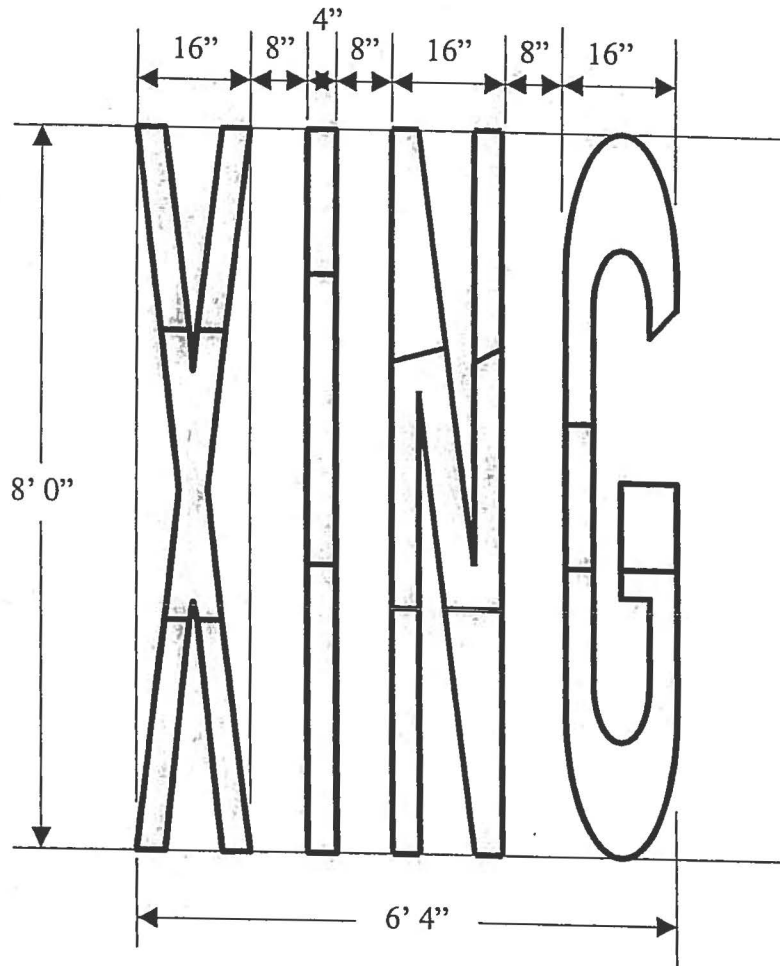

8' "X-ING"

Premark Design Number

130107



8' "XING" w/1.5" Contrast

FLINT TRADING, INC.

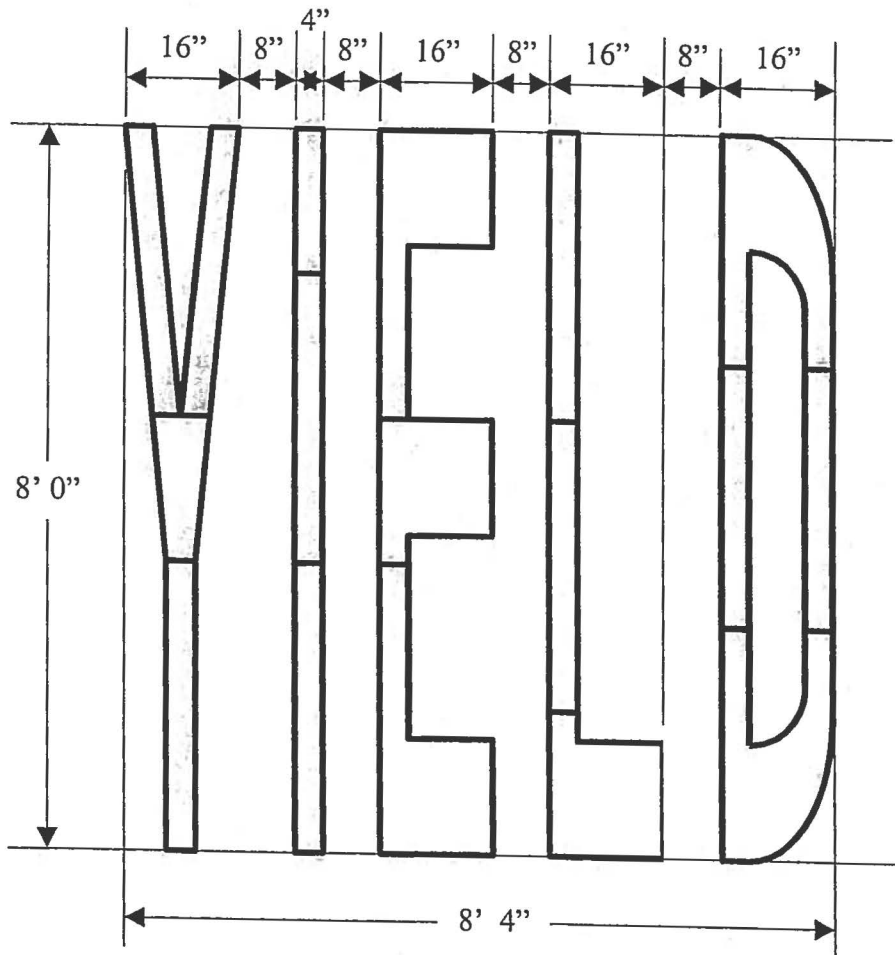

8' "YIELD"

Premark Design Number 130127

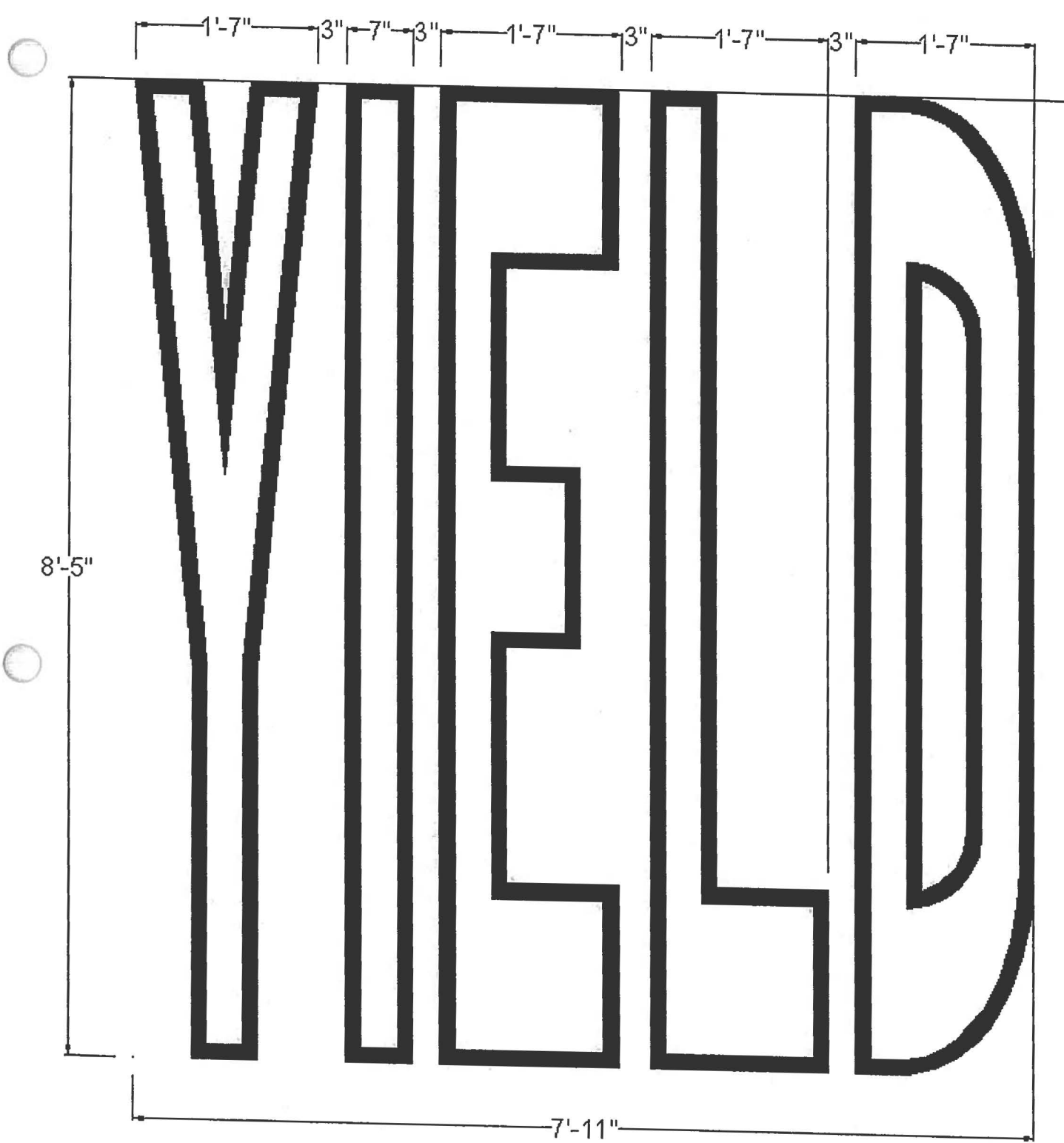
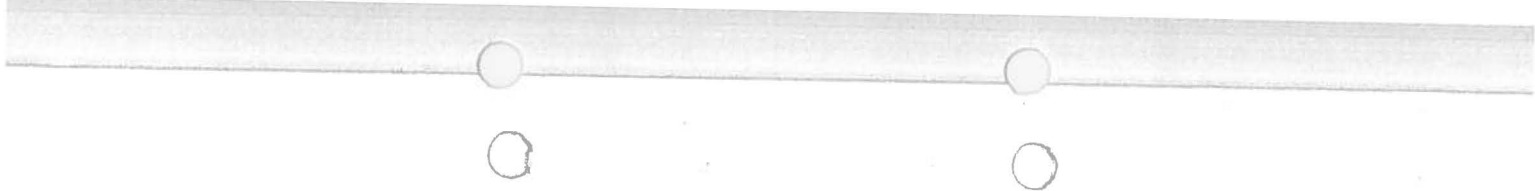

8' "YIELD" W/ 1.5" Contrast

Design Number

8130127-CONT

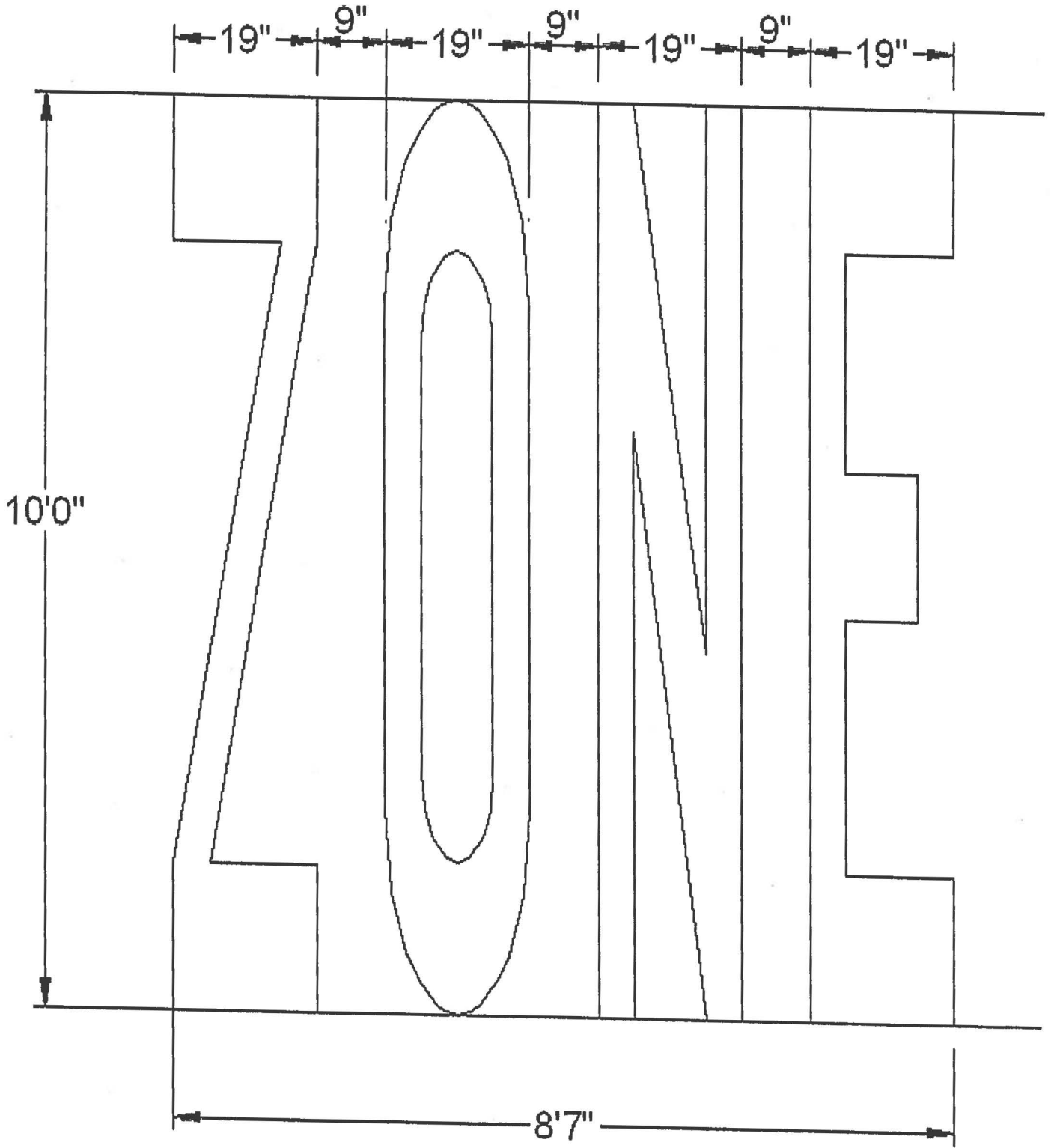

10' "ZONE"

PREMARK Design Number

120133

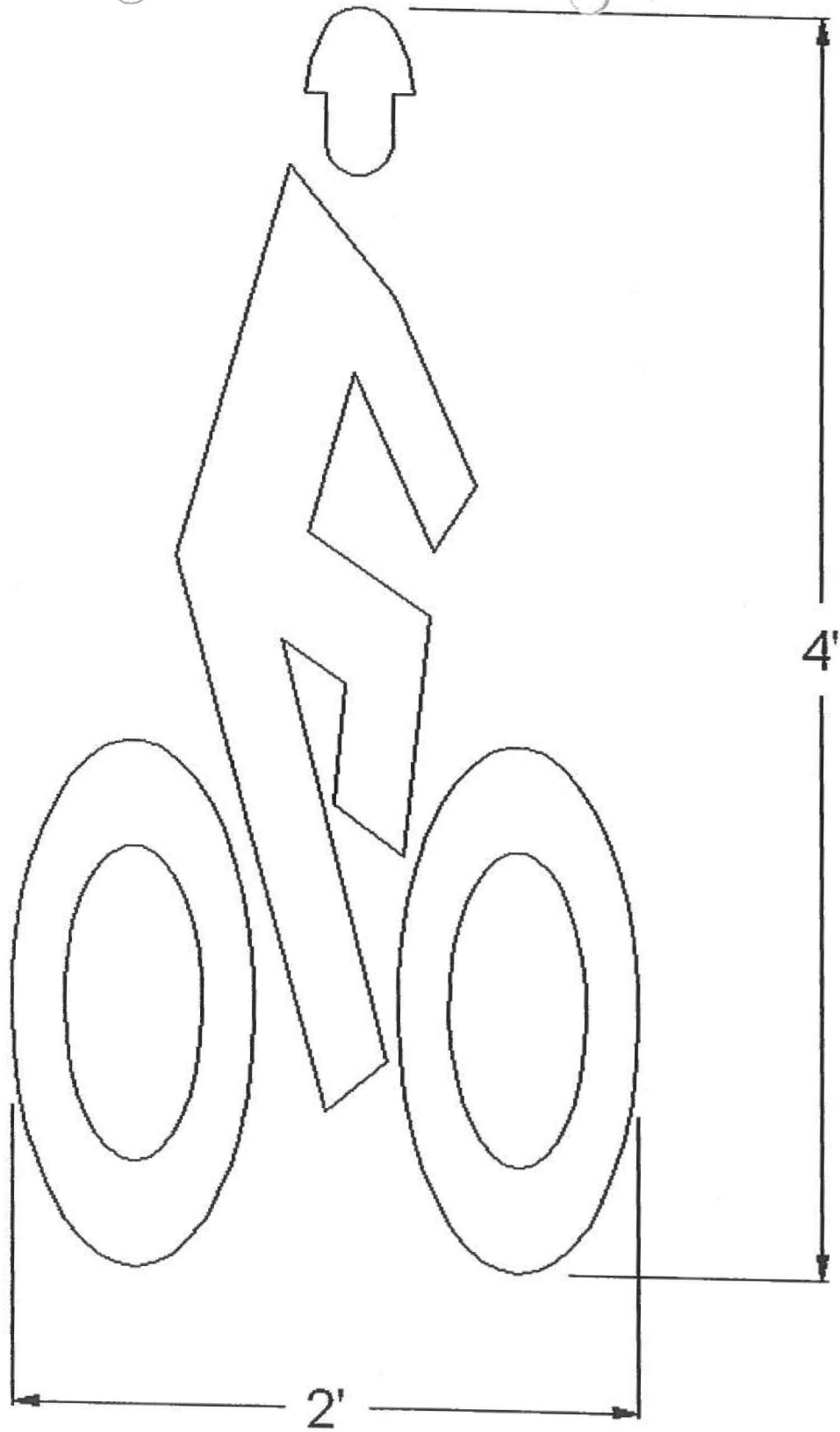

4' X 2' RIGHT BIKE LANE SYMBOL

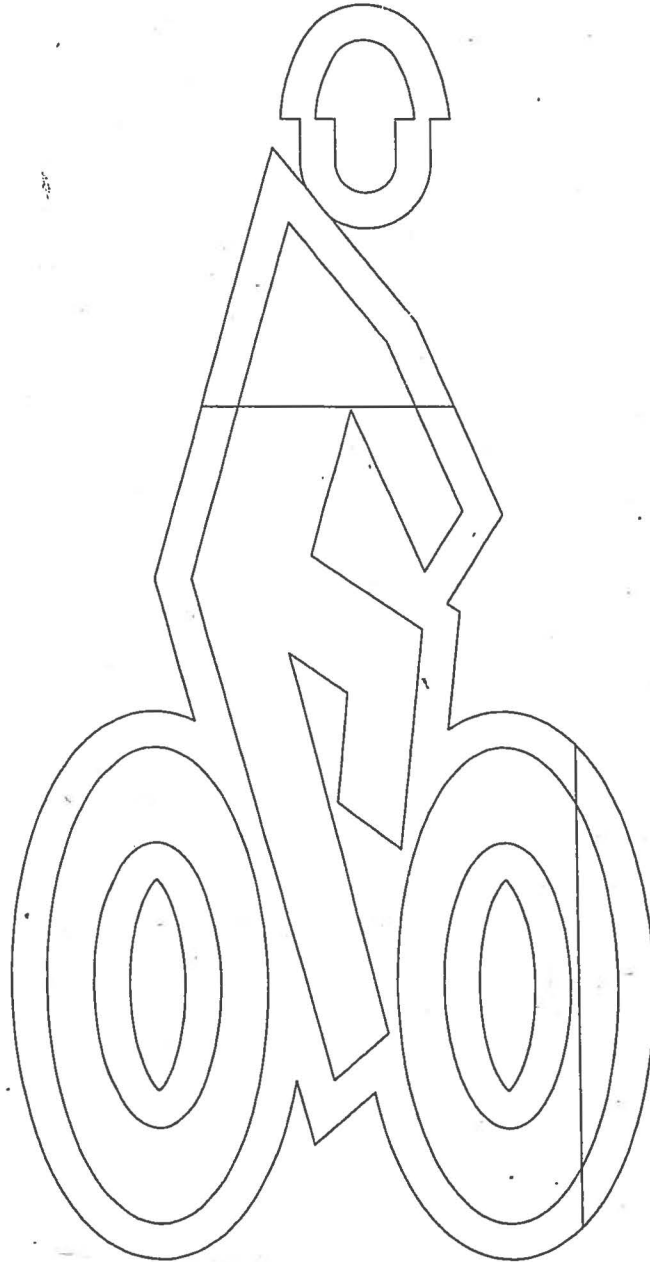

4' X 2' BIKE LANE SYMBOL W/1.5" CONTRAST

PREMARK Design Number

230525-CONT

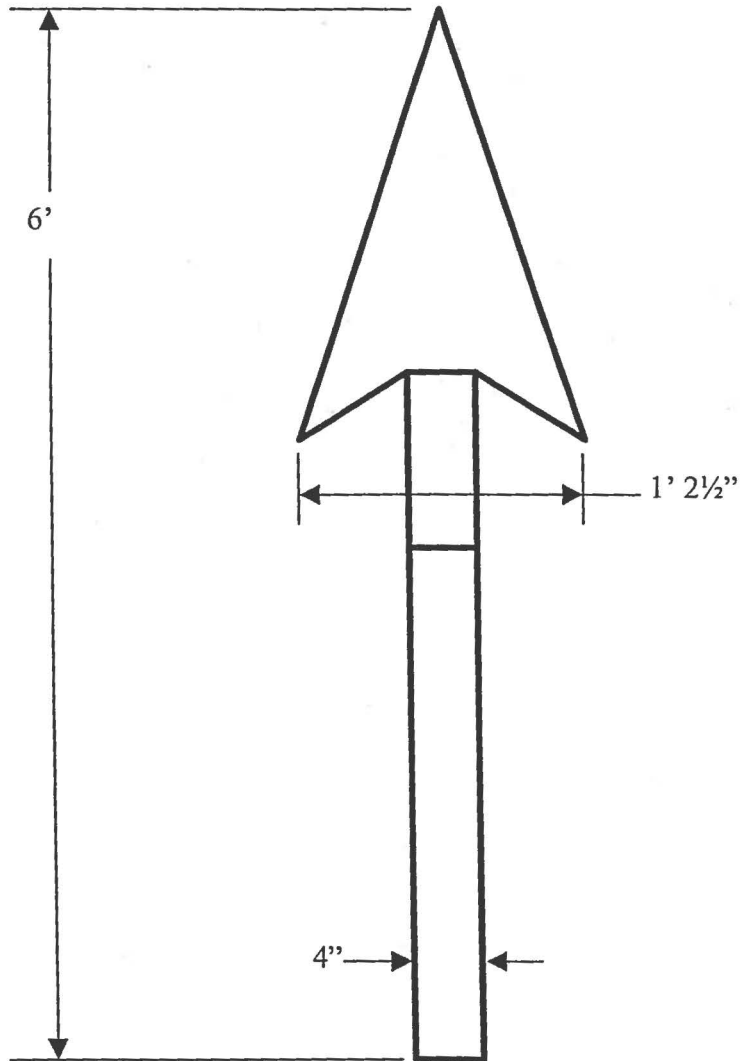

6' MINI - STRAIGHT ARROW

Premark Design Number

330558

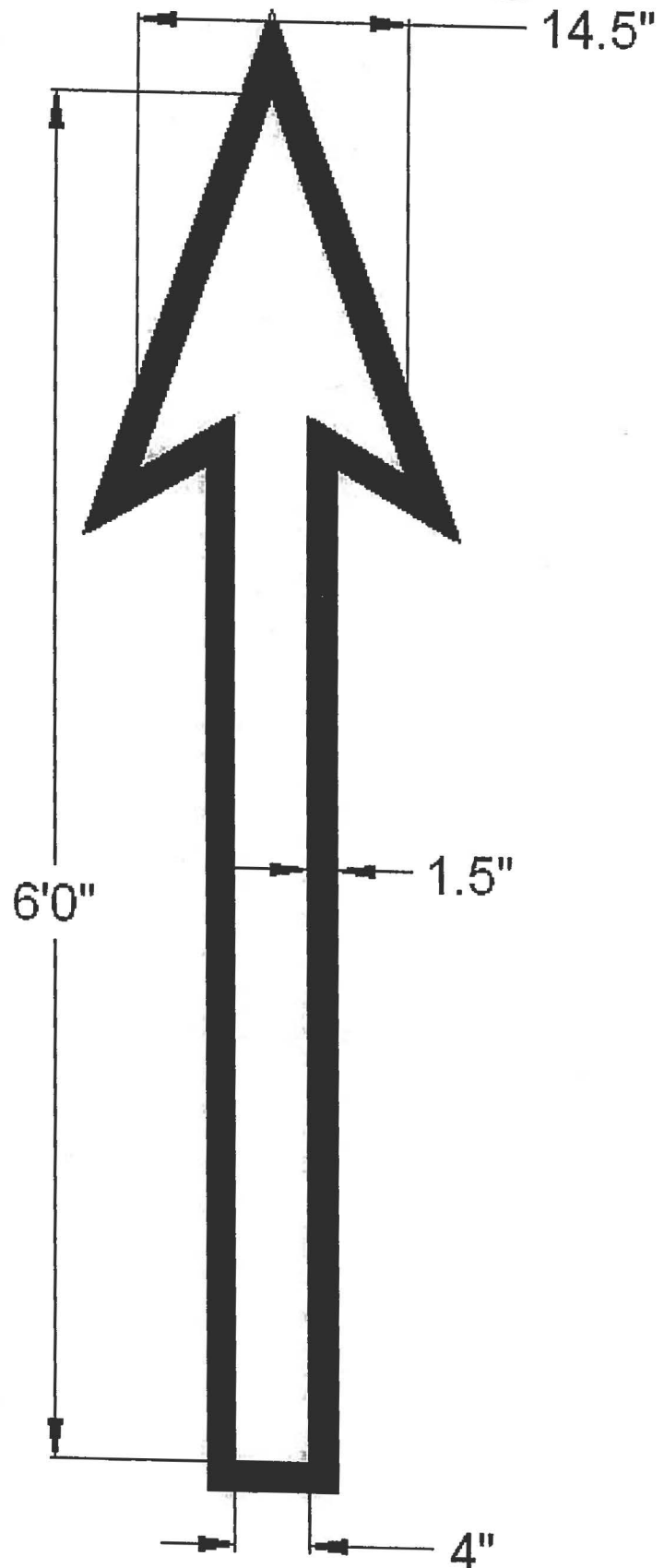

6' Mini Str Arrow W/Cont



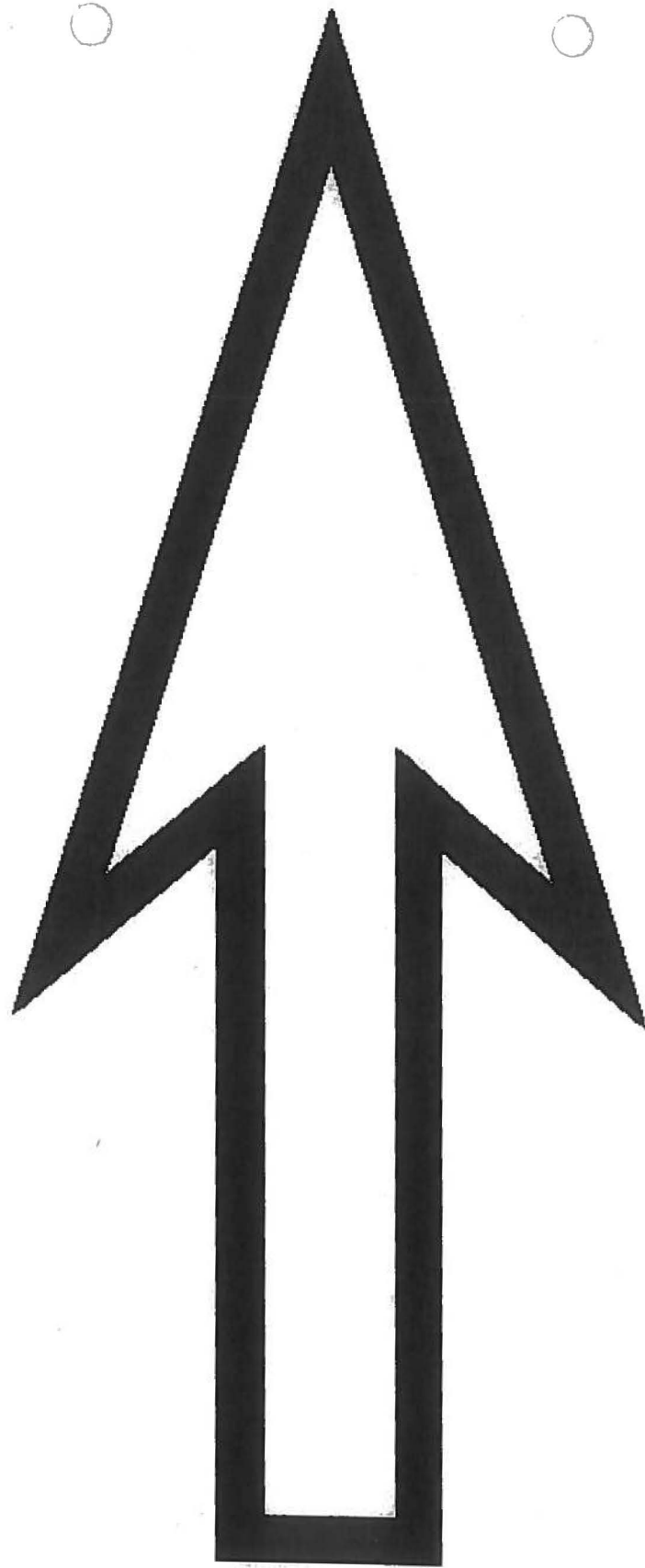

9'10" STRAIGHT ARROW W/4" CONTRAST

FLINT TRADING, INC.

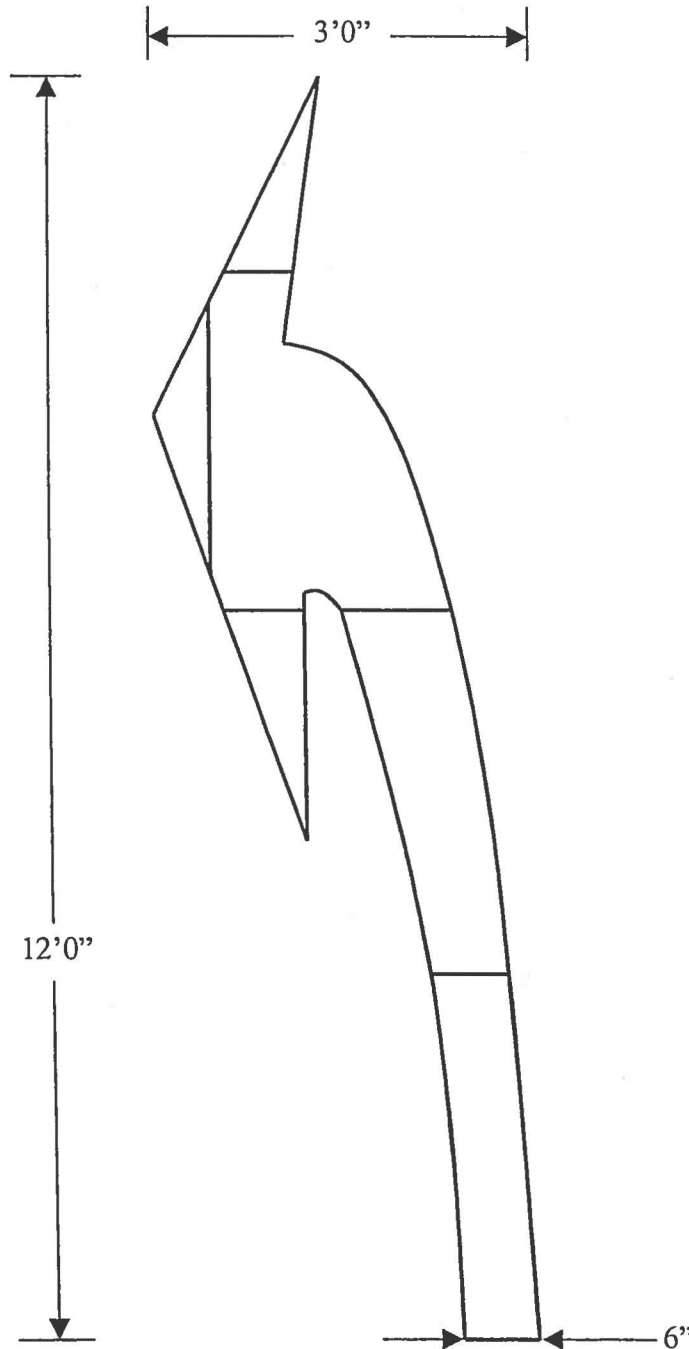

12' TURN ARROW NEW FHWA

Premark Design Number 330247

(Left Arrow Set Up As Shown, Right Arrow Reverse Image)

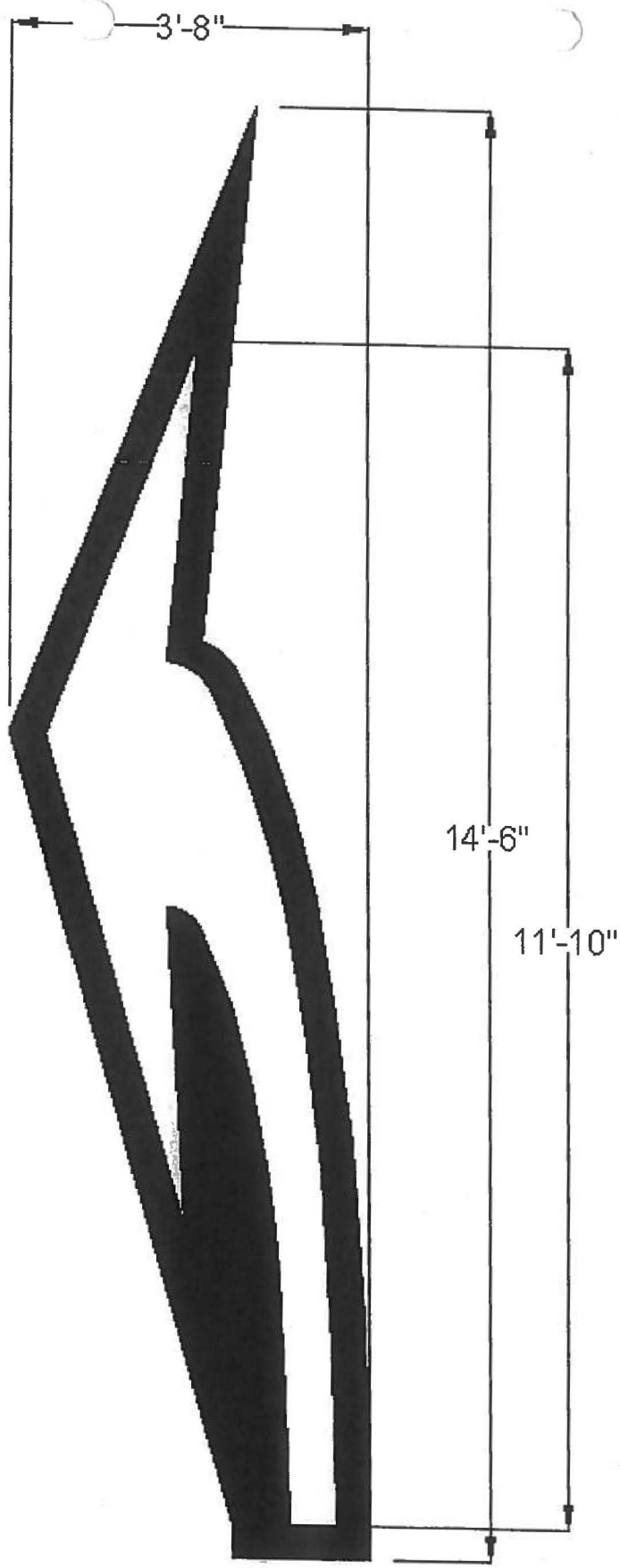

12' Left Turn Arrow w/4" contrast

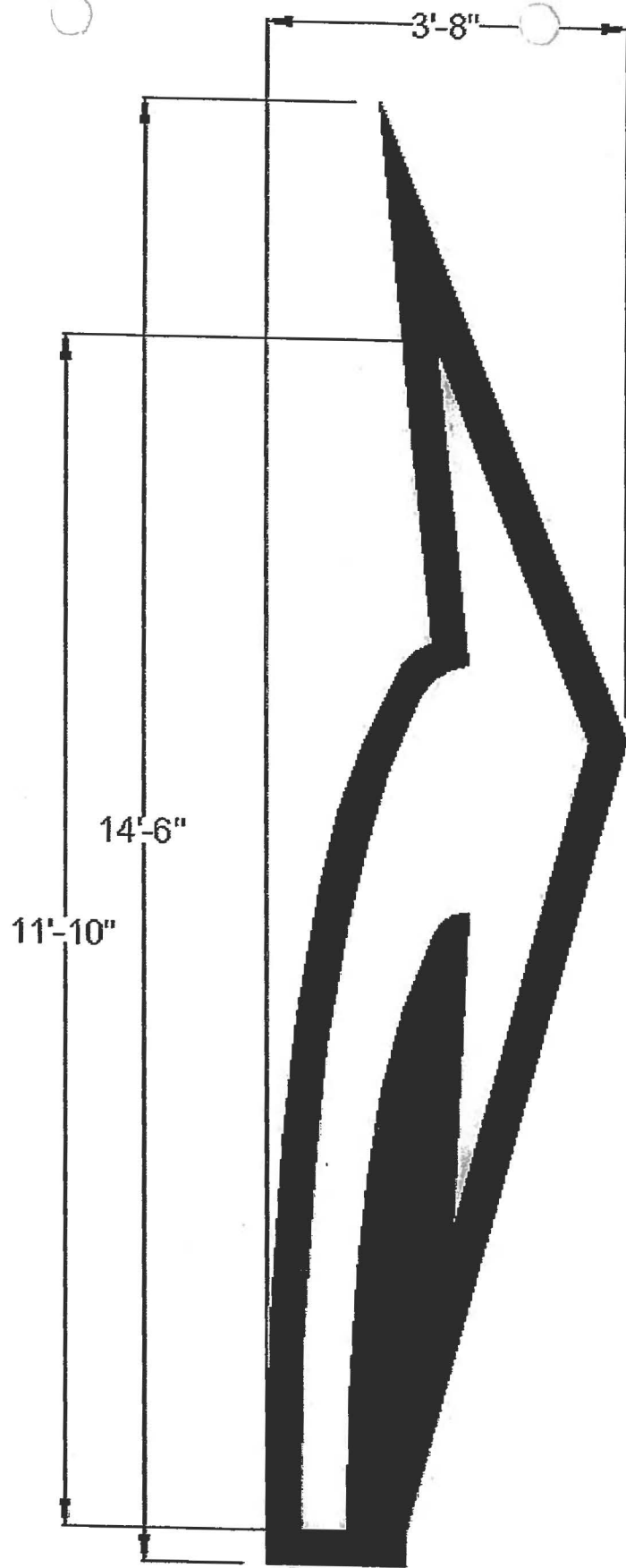

12' Right Turn Arrow w/4" contrast

FLINT TRADING, INC.

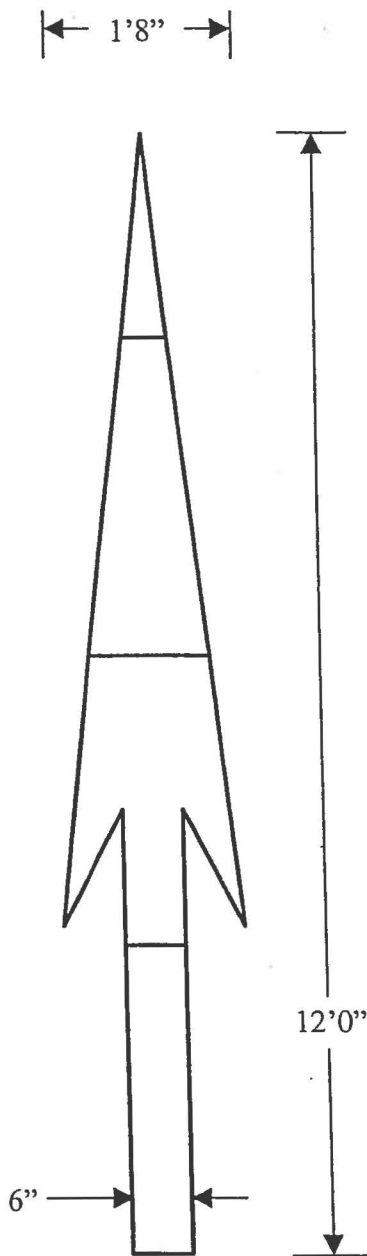

12' STRAIGHT ARROW NEW FHWA

Premark Design Number

330248

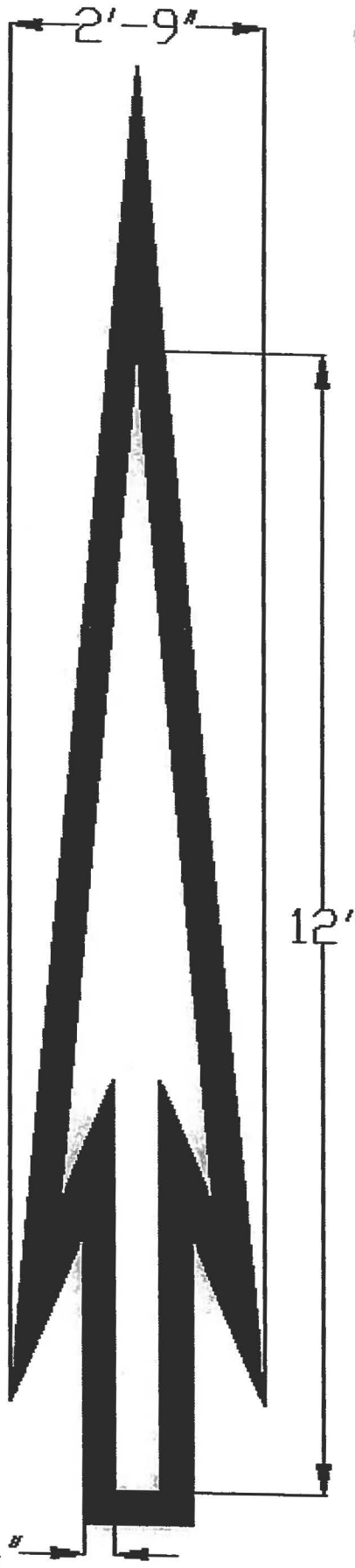

12' STRAIGHT ARROW CONTRAST

FLINT TRADING, INC.

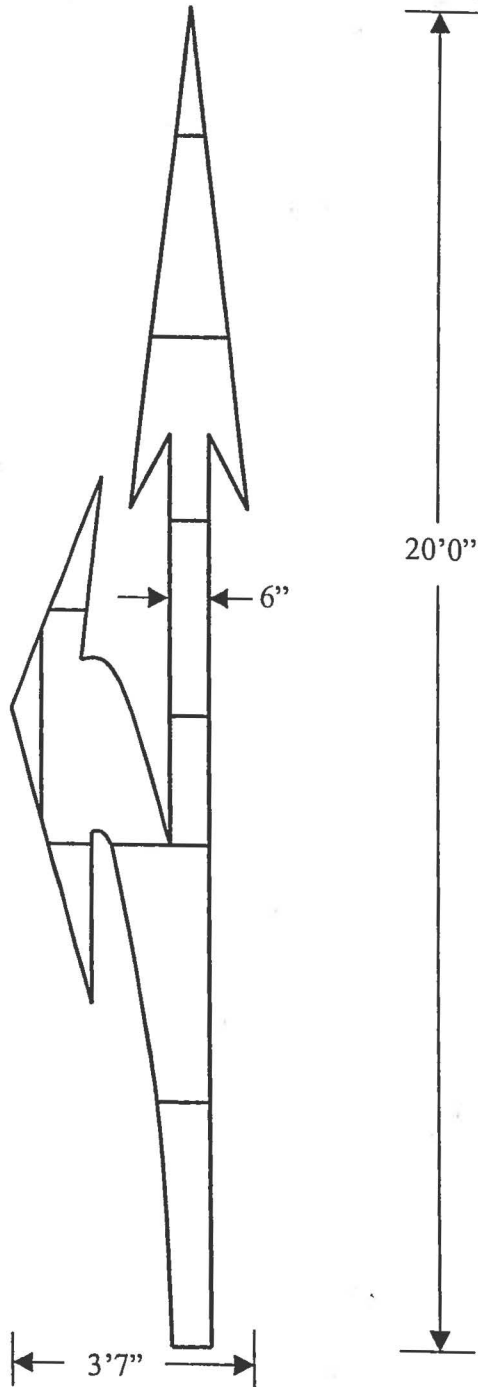

20' COMBI ARROW NEW FHWA

Premark Design Number 330149

(Left Arrow Set Up As Shown, Right Arrow Reverse Image)

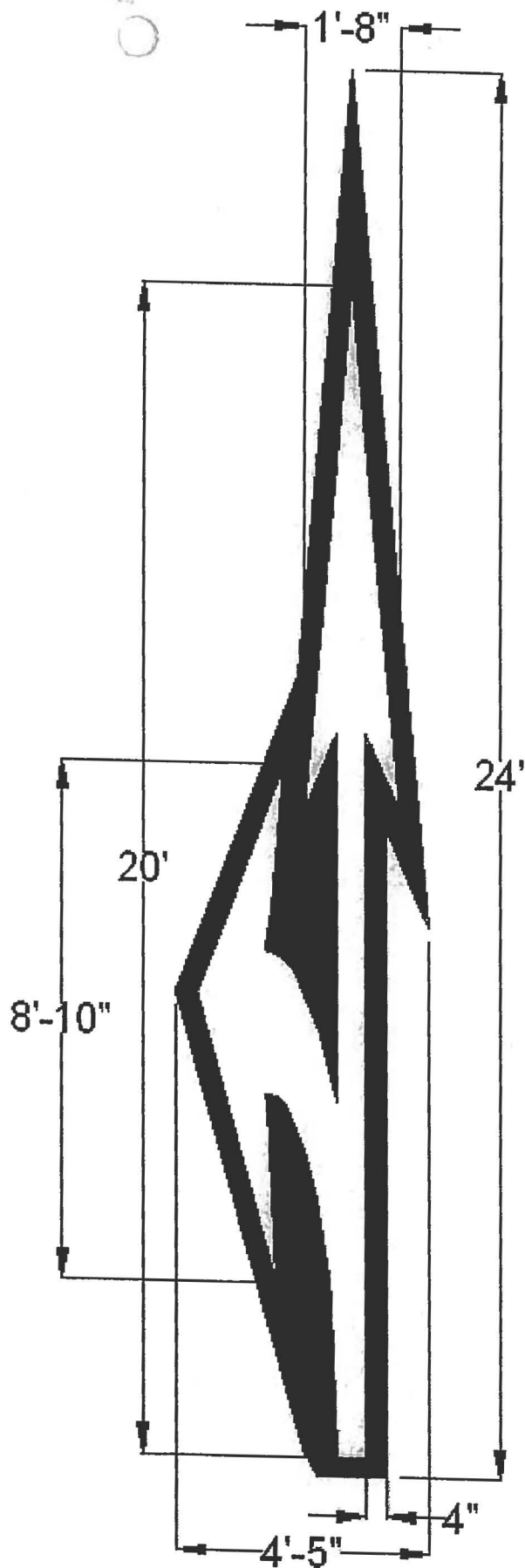

20' COMBI ARROW LEFT - NEW FHWA

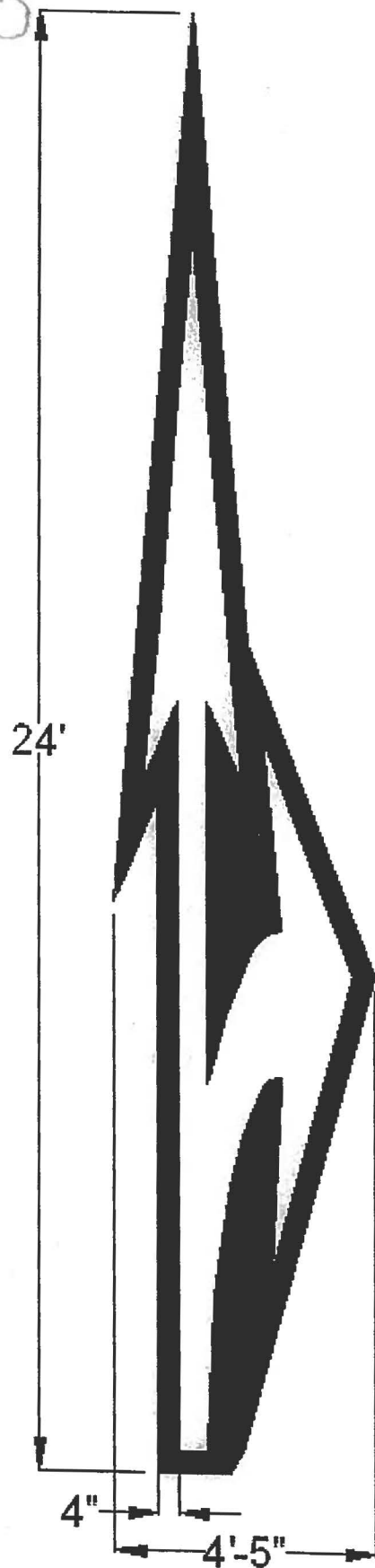

20' COMBI ARROW RIGHT W/CONTRAST